



ZK

cable service box

for overhead line and underground cable applications

short-circuit and overload protective device.



APPLICATIONS

Short-circuit and overload protective device (equipped with RBK 00/RBK 000 fuse switch disconnecter or PBD 00 fuse base)

- power supply point
- junction box for overhead lines and underground cables)
- main switch disconnector

ZK cable service box provides:

- reliable and versatile design for use in wide range of applications
- reduction of energy losses
- reduction of possibility of energy theft
- high reliability and safety of operation

CONSTRUCTION

ZK cable service box is made of flame retardant and fully recyclable polycarbonate. ZK cable service box material is resistant to ambient conditions, UV radiation, petrol, cubricating oil, oil, damage made by rodents.

CONFORMITY WITH STANDARDS

PN-EN 60439-1, PN-EN 60439-5, PN-EN 50298

Table 78. TECHNICAL DATA

Parameters	Value
Rated current (with fuse links)	100 A
Rated current (with solid links „00“ nr art.: 1115282188T)	125 A
Rated voltage	690 V
Power dissipation	40 W
Degree of protection of enclosure	IP54 IK10
Class of protection 	II
Rated impulse withstand voltage U_{imp}	6,0 kV
Pollution degree	3
Ambient temperature	-25°C ÷ +40°C
Operating time	>20 lat
Certified with „B“ safety mark	B
Certified with mark	CE

ZK cable service box can be protected from unauthorised access by seal or padlock.



ZK/RBK 00/PEN
ZK/RBK 00/PEN/T

APPLICATIONS



ZK

ZK/RBK 00/PEN
ZK/RBK 00/PEN/TZK/RBK 000/OPW
ZK/RBK 000/OPW/TZK/RBK 000/RB
ZK/RBK 000/RB/T

ZK/LZG35-16

MOUNTING

ZK cable service box can be mounted:

- on the wall
- inside feeder pillar
- on electric traction pole

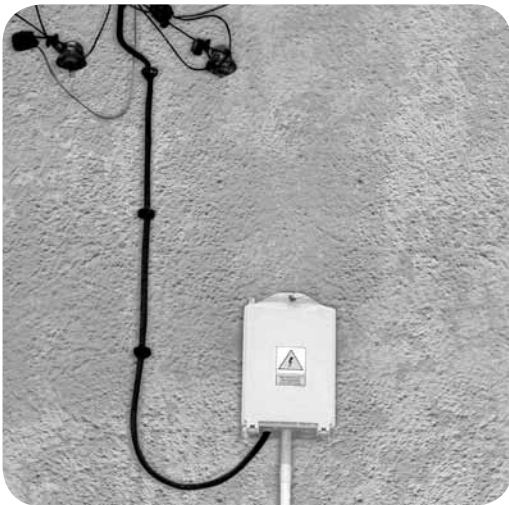

**ZK CABLE SERVICE BOX VERSIONS AND ACCESSORIES**

Table 79. STANDARD VERSIONS

Equipped with	Article
installed: PEN bar with V-terminal clamps	ZK
installed: fuse switch disconnecter RBK000, PEN bar with V-terminal clamps	ZK/RBK 000
installed: fuse switch disconnecter RBK00, PEN bar with V-terminal clamps	ZK/RBK 00
installed: fuse base PBD 00VV with V-terminal clamps, PEN bar with V-terminal clamps	ZK/PBD 00



ZK/PBD 00

Table 80. VERSIONS WITH TRANSPARENT COVER

Equipped with	Article
installed: PEN bar with V-terminal clamps	ZK/T
installed: fuse switch disconnecter RBK000, PEN bar with V-terminal clamps	ZK/RBK 000/T
installed: fuse switch disconnecter RBK00, PEN bar with V-terminal clamps	ZK/RBK 00/T
installed: fuse base PBD 00VV with V-terminal clamps, PEN bar with V-terminal clamps	ZK/PBD 00/T



ZK/RBK 00/T

Table 81. ACCESSORIES

	Article
Cable gland IP68 (cable diameter f = 10-14 mm)	DP16H
Cable gland IP68 (cable diameter f = 14-18 mm)	DP21H
Cable gland IP68 (cable diameter f = 18-25 mm)	DP29H
Cable gland IP68 (cable diameter f = 24-32 mm)	DP36H
Saddles (set - 2 pcs.)	LS
Steel band	COT 37
Steel band clamp (set - 2 pcs.)	COT 36

equipment for tightening steel band is necessary for mounting ZK cable service box on electric traction pole.



DP16H - DP36H



LS

APPLICATIONS ON CUSTOMER'S REQUEST



ZK/RBK 000/RB
ZK/RBK 000/RB/T



ZK/RBK 000/OPW
ZK/RBK 000/OPW/T



ZK/RBK 00/PEN
ZK/RBK 00/PEN/T



ZK/LZG35-16



DIMENSIONS

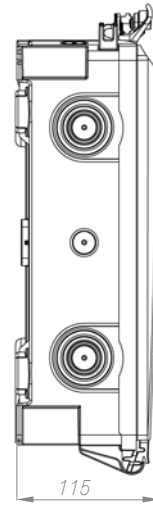
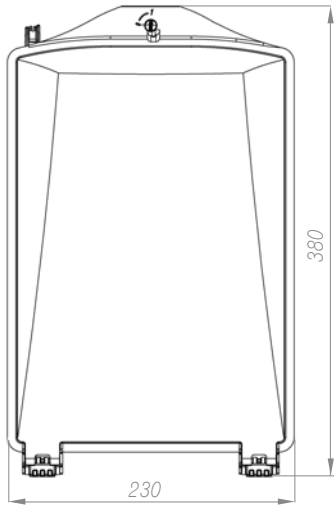

ZK cable service box can be mounted on the wall of the building or in feeder pillar

- clamps
- outer fixing holes
- inner fixing holes (drilled)

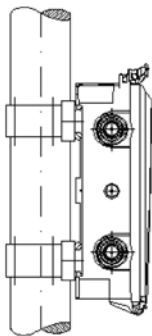
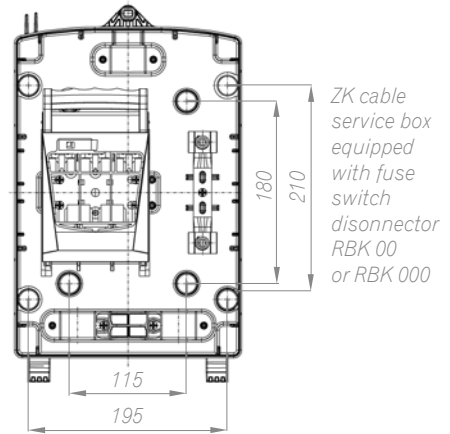
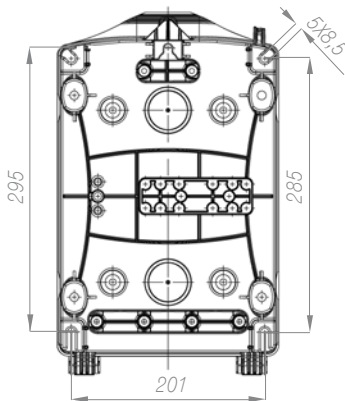

Mounting on electric traction pole

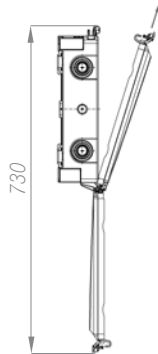

Opening of cover, cover can be removed at angle of 30°

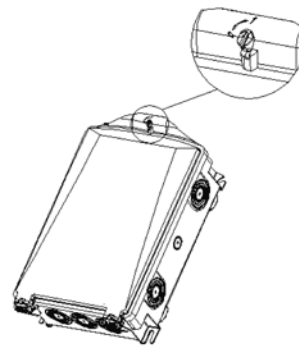

Sealing point

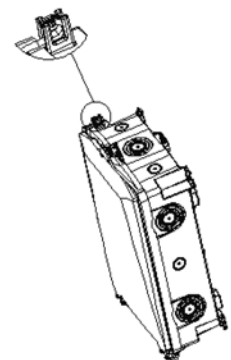

Padlocking point

DIMENSIONS

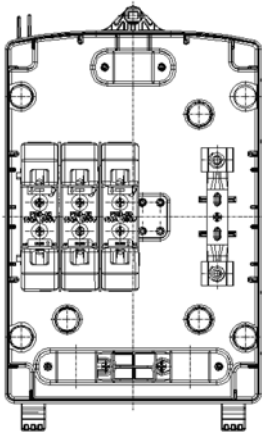

ZK cable service box equipped with 3-pole or 4-pole fuse base PBD 00

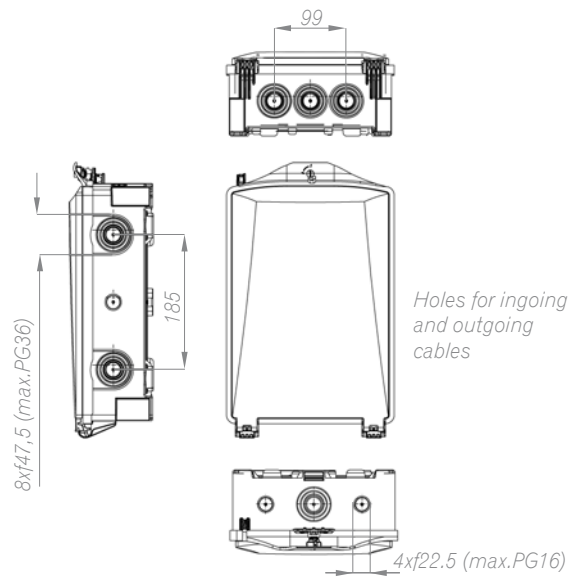

EQUIPMENT

ZK cable service box depending on customers needs can be equipped with:

- fuse switch disconnecter RBK 00 - with screw terminals or S-bridge clamps
- fuse switch disconnecter RBK 000 - with screw terminals or S-bridge clamps
- fuse base PBD 00, 3-pole - with V-terminal clamps
- fuse base PBD 00, 4-pole - with V-terminal clamps
- cable glands IP68
- PEN bar with V-terminal clamps
- saddles

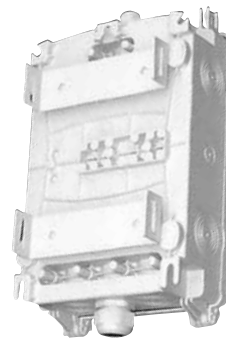

ZK cable service box with saddles for mounting on electric traction pole